



Track, Components & Accessories
Single Circuit



1M TRACK LENGTH

AC 240V
16A

	T510-W
	T510 S
	T510-B

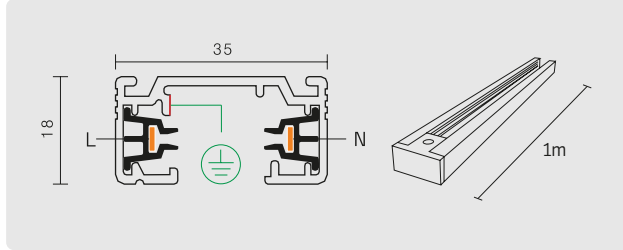

2M TRACK LENGTH

AC 240V
16A

	T520-W
	T520 S
	T520-B

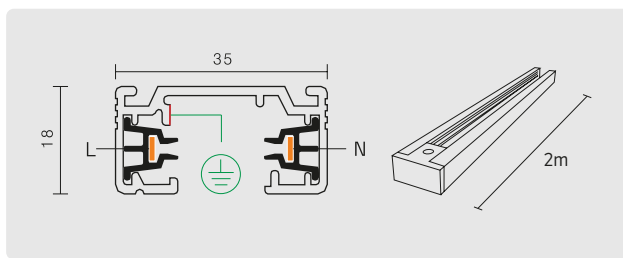

3M TRACK LENGTH

AC 240V
16A

	T530-W
	T530 S
	T530-B

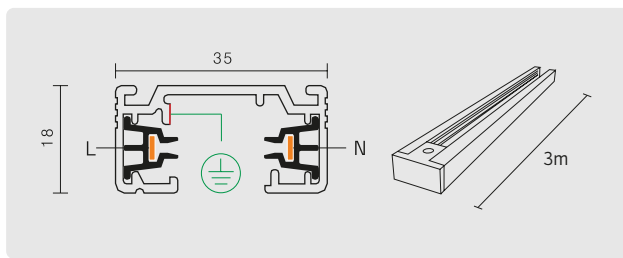

Single Circuit Track lengths are supplied with pre-installed end Mains Connection (Earth Left) and End caps unless specified otherwise.



**MAINS CONNECTION
 EARTH LEFT**
 AC 240V
 16A

- T540-MLW**
- T540 MLS**
- T540-MLB**

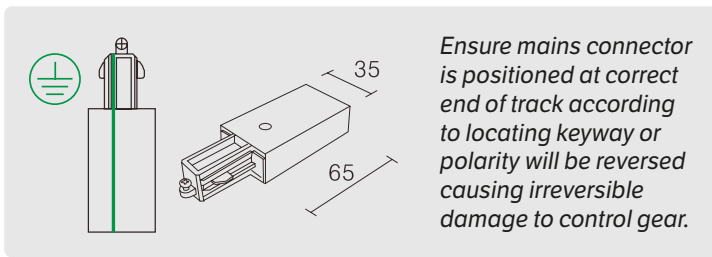

**MAINS CONNECTION
 EARTH RIGHT**
 AC 240V
 16A

- T540-MRW**
- T540 MRS**
- T540-MRB**

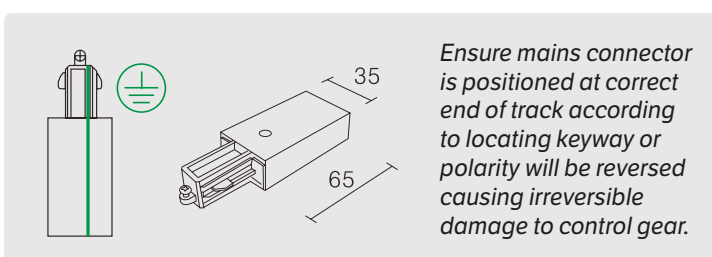

**CENTRE MAINS
 CONNECTION**
 AC 240V
 16A

- T548-CW**
- T548 CS**
- T548-CB**

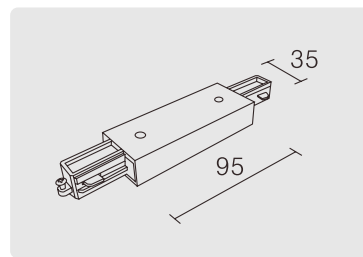

**"L" JOIN
 EARTH INSIDE**
 AC 240V
 16A

- T543-LIW**
- T543 LIS**
- T543-LIB**

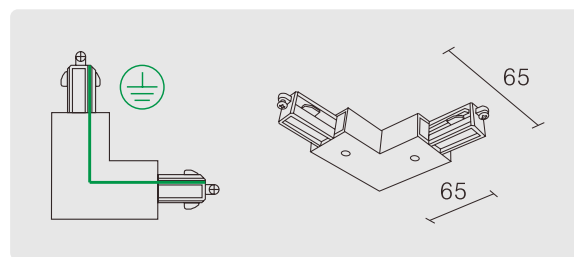

**"L" JOIN
 EARTH OUTSIDE**
 AC 240V
 16A

- T543-LOW**
- T543 LOS**
- T543-LOB**

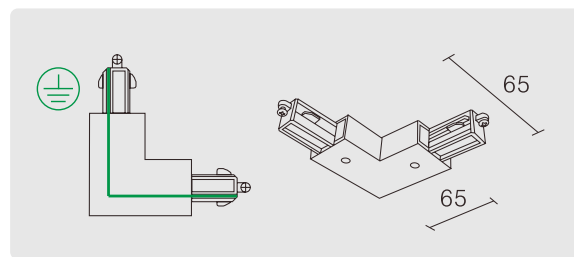



**“T” JOIN
EARTH LEFT**
AC 240V
16A

- T544-TLW
- T544 TLS
- T544-TLB

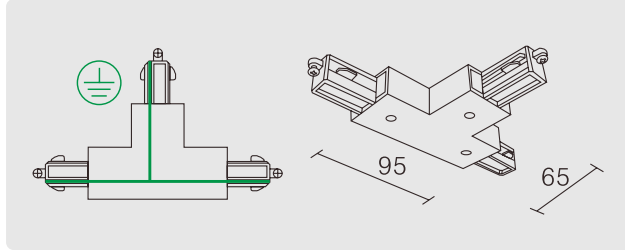

**“T” JOIN
EARTH RIGHT**
AC 240V
16A

- T544-TRW
- T544-TRB

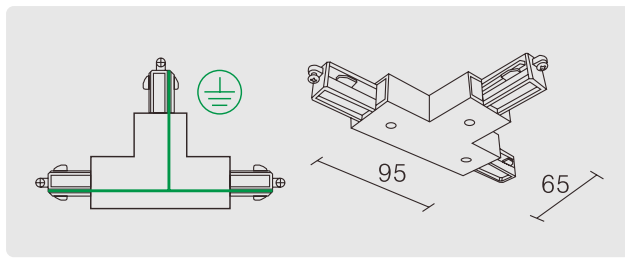

**STANDARD JOIN
STRAIGHT**
AC 240V
16A

- T542-JW
- T542 JS
- T542-JB

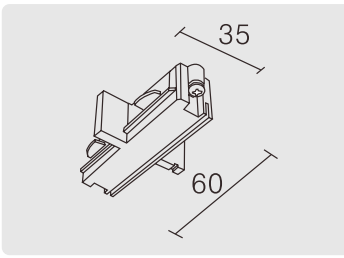

FLEXIBLE JOINT
AC 240V
16A

- T546-FW
- T546 FS
- T546-FB

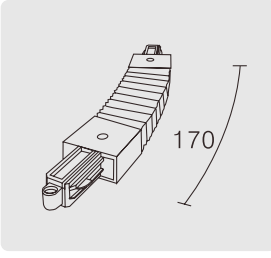

**1 CIRCUIT MAINS
ADAPTOR WITH
CORD GRIP**

- T552-TAW
- T552 TAS
- T552-TAB

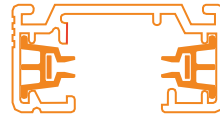

TRACK END CAP
Plastic

- T541-EW**
- T541 ES**
- T541-EB**

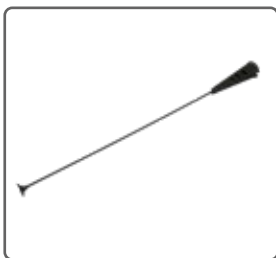
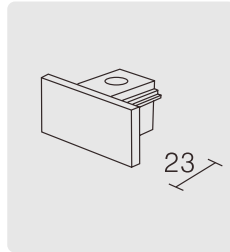

SUSPENSION ROD
0.2 - 1m
Max Load 200nm

- T549-RW**
- T549 RS**
- T549-RB**

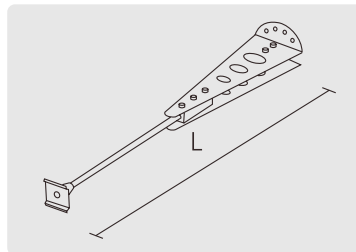

SUSPENSION CABLE
3M
Max Load 100nm

- T547-SW**
- T547 SS**
- T547-SB**

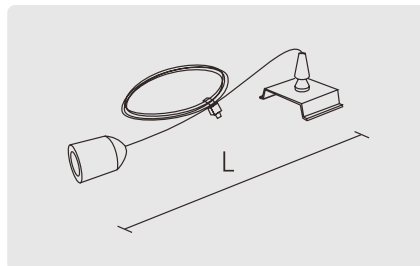

SURFACE MOUNT ADAPTER
Diameter 115mm

- T249-CMW**
- T249-CMB**

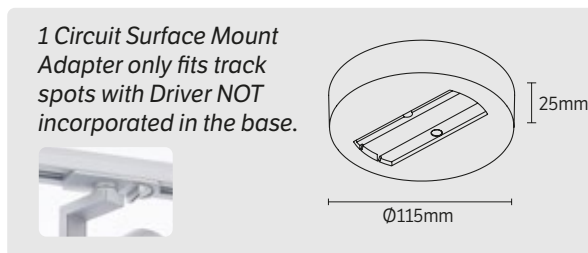

TRACK COVER
Available in Black
2m lengths only.
Custom cut to suit installation.

- T100-TCB**

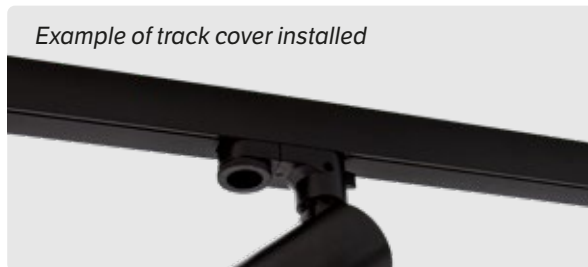



SINGLE CIRCUIT ADAPTER SECURING

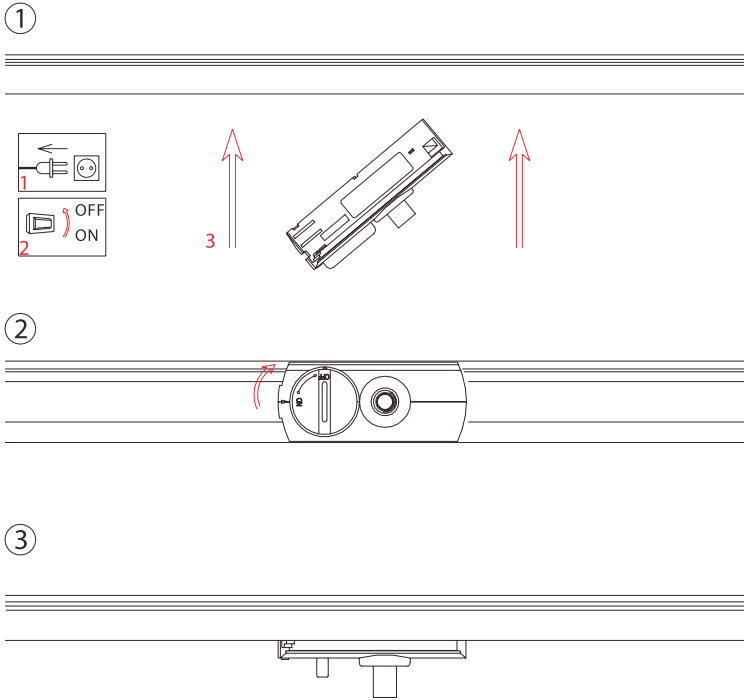

ELECTRICAL PARAMETERS

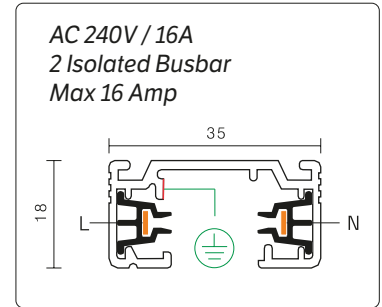

TRACK SECURING / LOADING

Installation Note: See screw locations on diagrams below for recommended spacing of fixing/suspension points. Halcyon recommends suspension/fixing approximately every 600-1000mm. Track lengths come complete with pre-drilled fixing points but are easily custom drilled to suit any installation.

1m Track Lengths

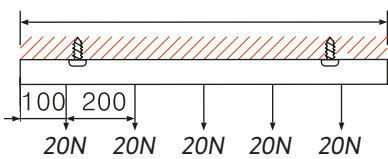

2m Track Lengths

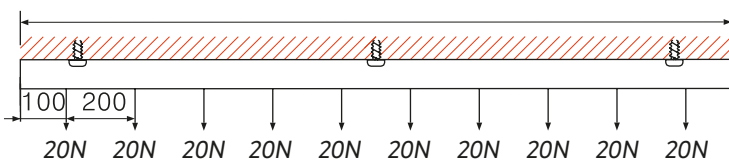

3m Track Lengths

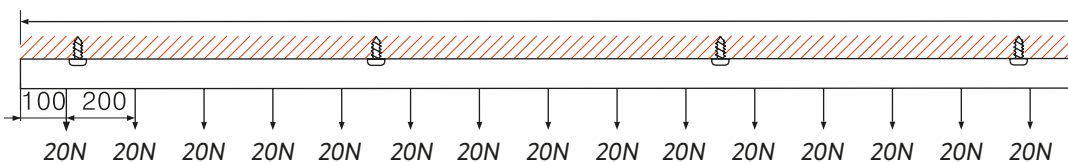

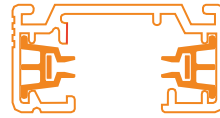

SINGLE CIRCUIT TRACK GRID EXAMPLE [IN WHITE]

Installation note: Corner adapters also have rear knockouts for termination. Always use strengthening plates over joins/adapters when suspending track structure.

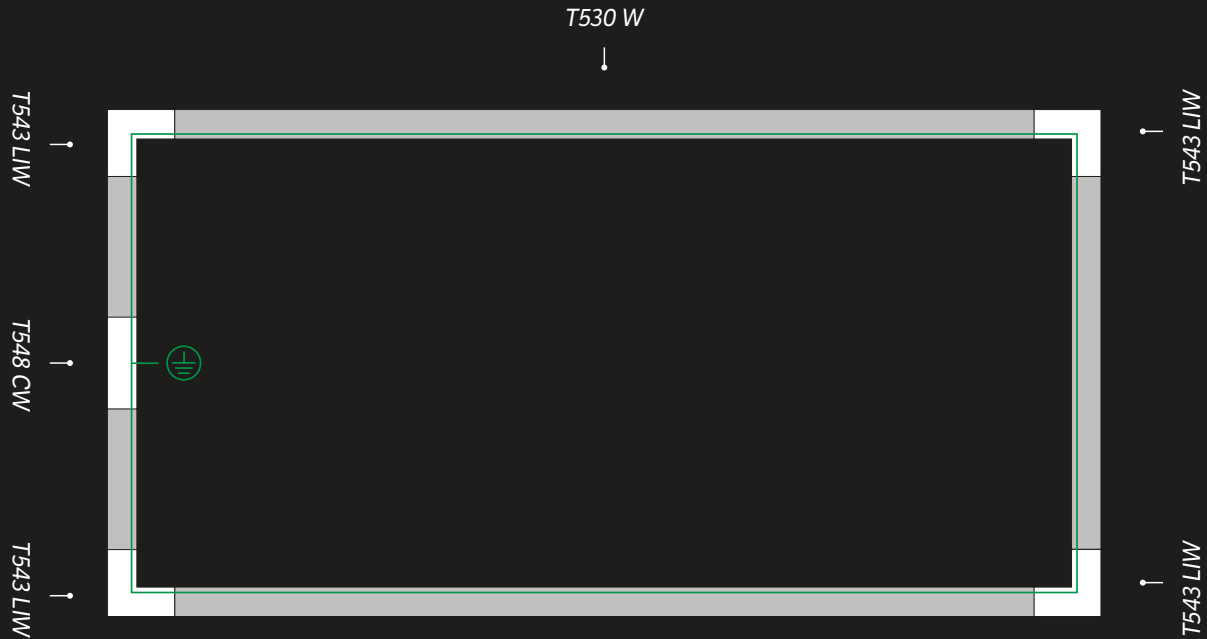

SINGLE CIRCUIT TRACK EXAMPLE [IN WHITE]

Installation note: Single lengths of single circuit track come with mains feed (earth left) and end cap pre fitted.

