

HALCYON

SINGLE CIRCUIT

TRACK COMPONENTS
& ACCESSORIES

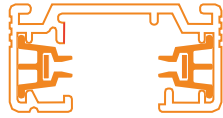

Track, Components & Accessories
Single Circuit



1M TRACK LENGTH

AC 240V
16A

	T510 W
	T510 S
	T510 B

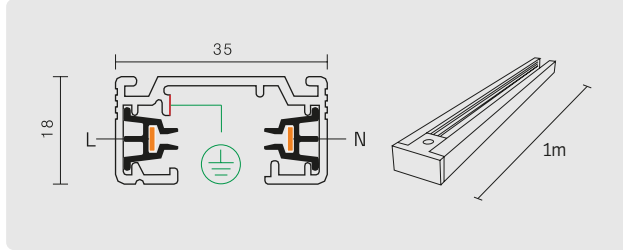

2M TRACK LENGTH

AC 240V
16A

	T520 W
	T520 S
	T520 B

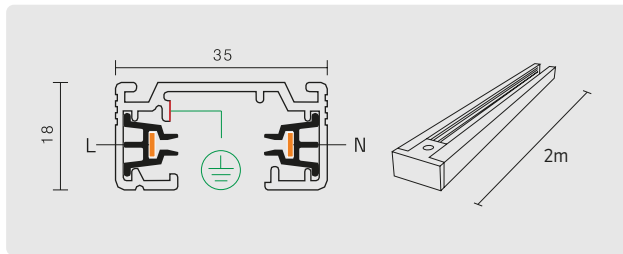

3M TRACK LENGTH

AC 240V
16A

	T530 W
	T530 S
	T530 B

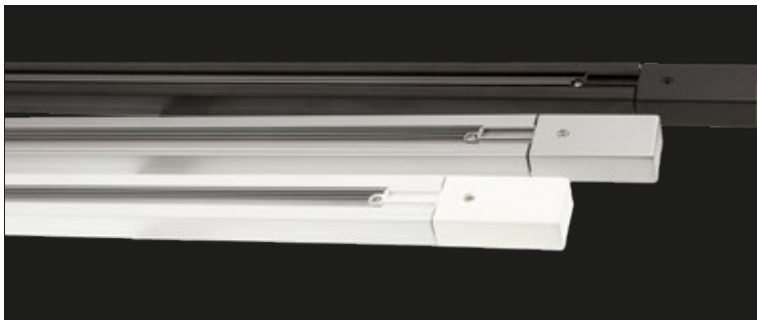
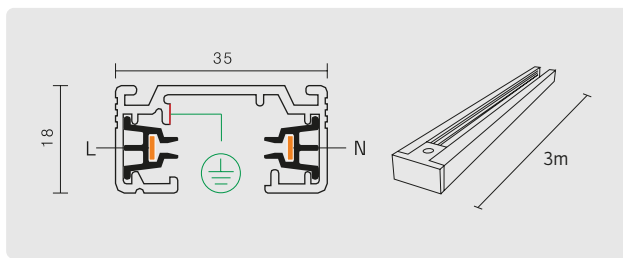

Single Circuit Track lengths are supplied with pre-installed end Mains Connection (Earth Left) and End caps unless specified otherwise.

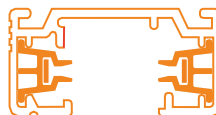

**MAINS CONNECTION
 EARTH LEFT**
 AC 240V
 16A

- T540 MLW**
- T540 MLS**
- T540 MLB**

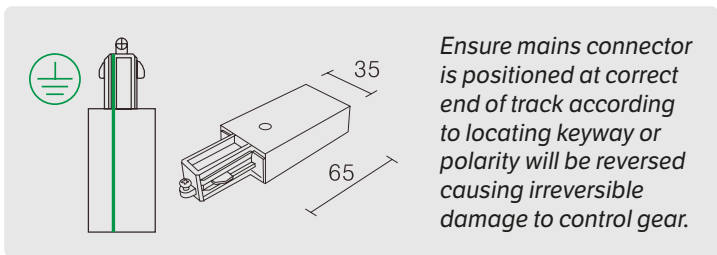

**MAINS CONNECTION
 EARTH RIGHT**
 AC 240V
 16A

- T540 MRW**
- T540 MRS**
- T540 MRB**

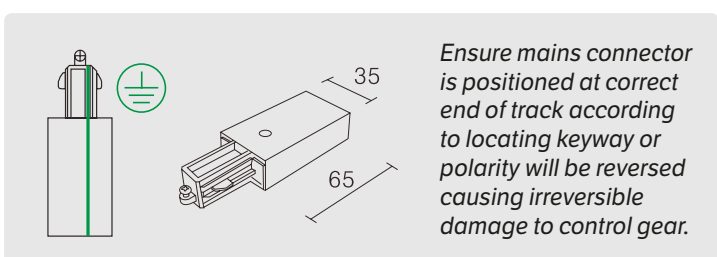

**CENTRE MAINS
 CONNECTION**
 AC 240V
 16A

- T548 CW**
- T548 CS**
- T548 CB**

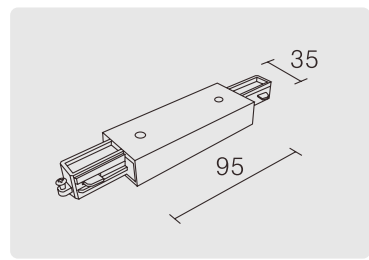

**"L" JOIN
 EARTH INSIDE**
 AC 240V
 16A

- T543 LIW**
- T543 LIS**
- T543 LIB**

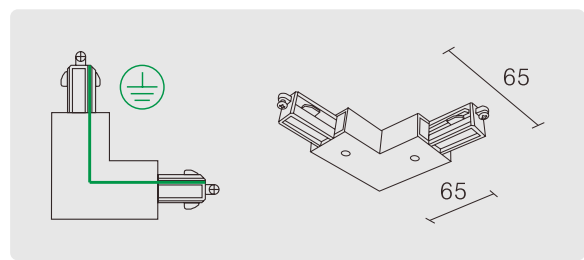

**"L" JOIN
 EARTH OUTSIDE**
 AC 240V
 16A

- T543 LOW**
- T543 LOS**
- T543 LOB**

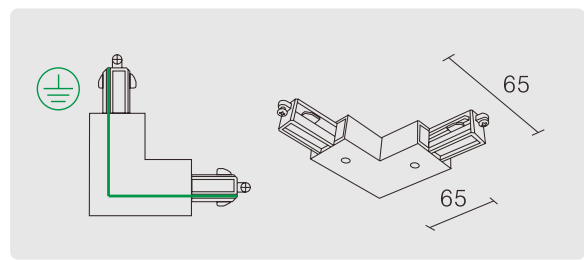



**"T" JOIN
EARTH LEFT**
AC 240V
16A

- T544 TLW**
- T544 TLS**
- T544 TLB**

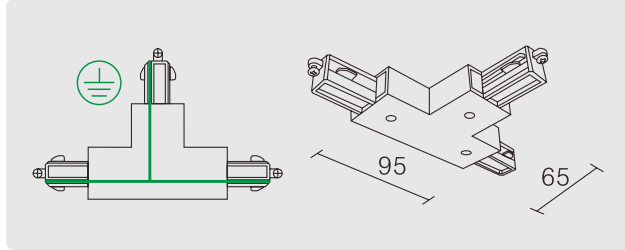

**"T" JOIN
EARTH RIGHT**
AC 240V
16A

- T544 TRW**
- T544 TRB**

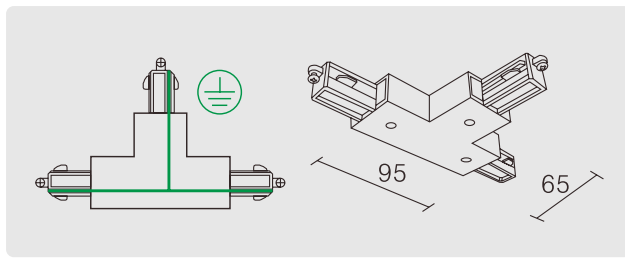

**STANDARD JOIN
STRAIGHT**
AC 240V
16A

- T542 JW**
- T542 JS**
- T542 JB**

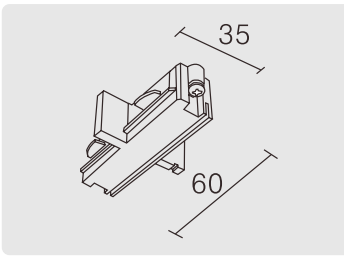

FLEXIBLE JOINT
AC 240V
16A

- T546 FW**
- T546 FS**
- T546 FB**

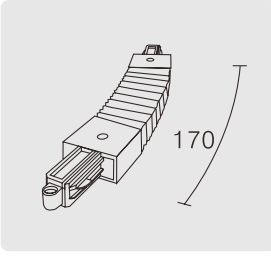

**1 CIRCUIT MAINS
ADAPTOR WITH
CORD GRIP**

- T552 TAW**
- T552 TAS**
- T552 TAB**

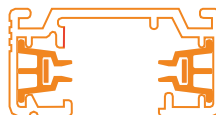

TRACK END CAP

Plastic

- T541 EW**
- T541 ES**
- T541 EB**

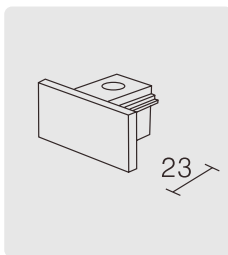

SUSPENSION ROD

0.2 - 1m

Max Load 200nm

- T549 RW**
- T549 RS**
- T549 RB**

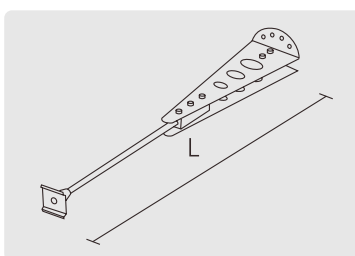

SUSPENSION CABLE

3M

Max Load 100nm

- T547 SW**
- T547 SS**
- T547 SB**

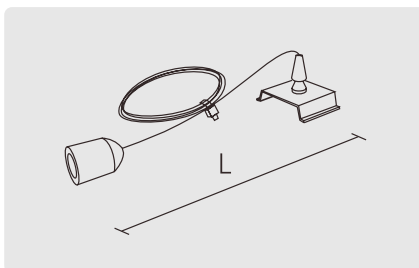

SURFACE MOUNT ADAPTER

Diameter 120mm

- T249 CMW**
- T249 CMS**
- T249 CMB**

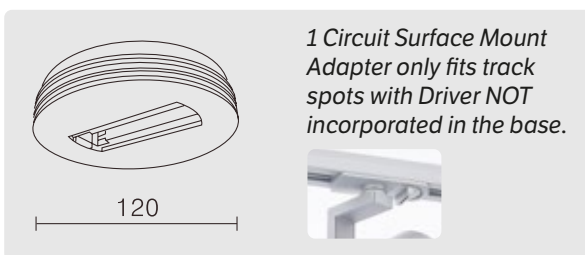

TRACK COVER

*Available in Black
 2m lengths only.
 Custom cut to suit
 installation.*

- T100 TCB**

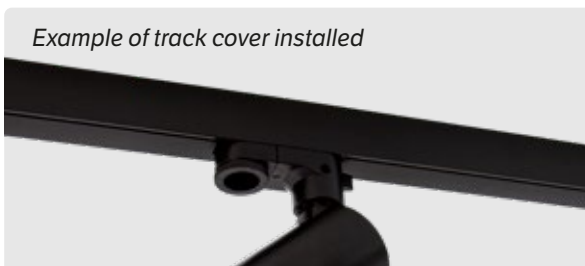



SINGLE CIRCUIT ADAPTER SECURING

ELECTRICAL PARAMETERS

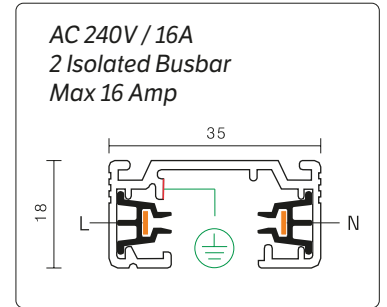
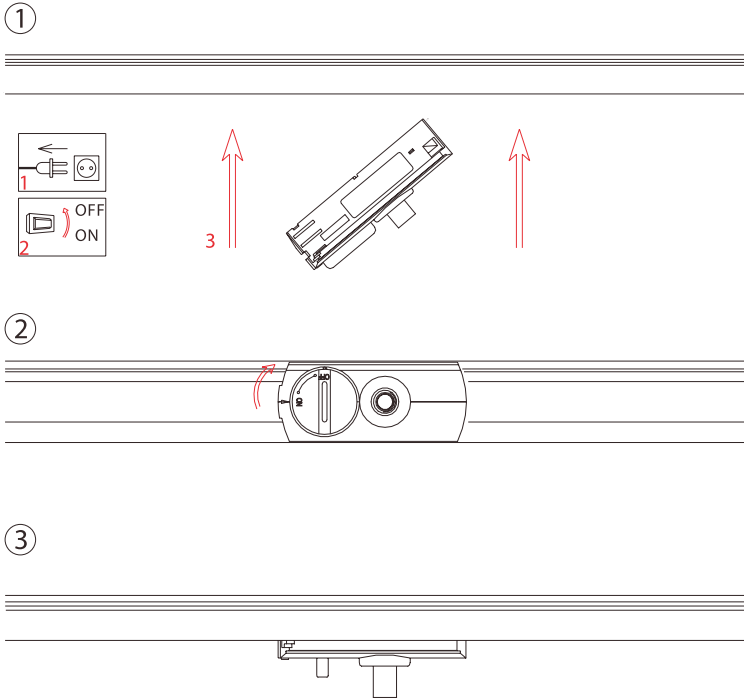

TRACK SECURING / LOADING

Installation Note: See screw locations on diagrams below for recommended spacing of fixing/suspension points. Halcyon recommends suspension/fixing approximately every 600-1000mm. Track lengths come complete with pre-drilled fixing points but are easily custom drilled to suit any installation.

1m Track Lengths

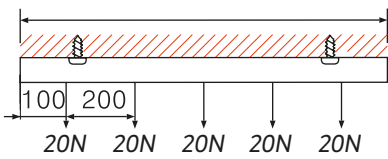

2m Track Lengths

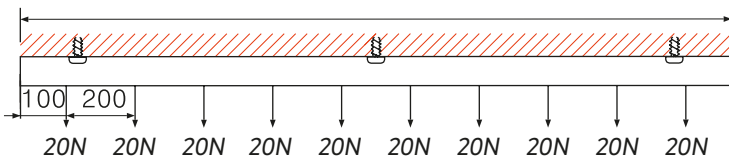

3m Track Lengths

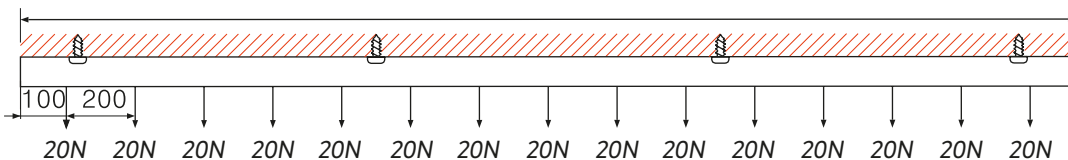

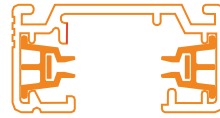

SINGLE CIRCUIT TRACK GRID EXAMPLE [IN WHITE]

Installation note: Corner adapters also have rear knockouts for termination. Always use strengthening plates over joins/adapters when suspending track structure.

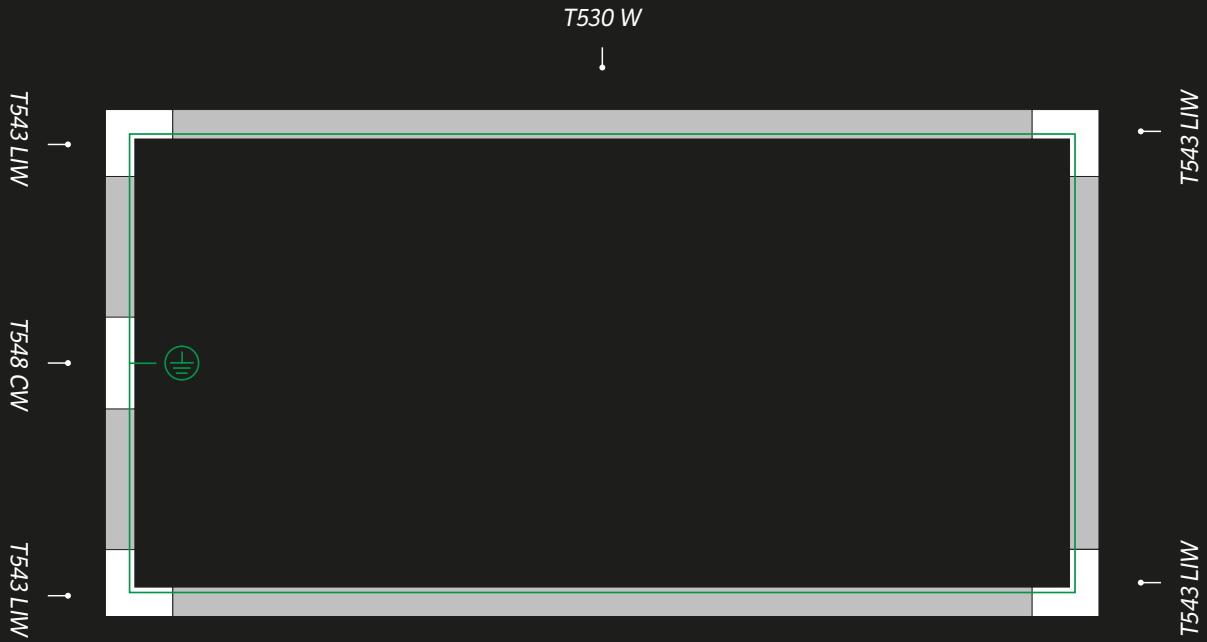

SINGLE CIRCUIT TRACK EXAMPLE [IN WHITE]

Installation note: Single lengths of single circuit track come with mains feed (earth left) and end cap pre fitted.

